



INSTALLATION AND OWNER'S INSTRUCTIONS

GAME LIGHT



1-877-321-MEGA

www.megaslamhoops.com

Copyright © Mega Slam Hoops, LLC

All rights reserved. Unauthorized copying is prohibited by law without written permission.

TABLE OF CONTENTS

Safety Instructions.....	2
Hardware.....	3
Hardware.....	4
Brace Attachment & Pole Assembly.....	5
LED Light & Lift Assist Assembly	6
Raising the Light Post... ..	7
Optional Net Protect Assembly.....	8
Maintenance & Inspection.....	9

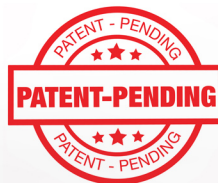

SAFETY INSTRUCTIONS



CAUTION



Owner/Purchaser must insure that all players have read these instructions and both know and follow these rules for the safe operation of the system.

To insure safety, DO NOT attempt to assemble this light system without following the instructions carefully. Proper and complete assembly, use and supervision, and full understanding of the instructions are essential for proper operation and to reduce the risk of accident or injury. A high probability of serious injury exists if this system is not installed, maintained, and operated properly.

Proper and complete assembly, use and supervision is essential for proper operation of the product and to reduce the risk of accident or injury.

Use caution when using this light system. Most injuries are caused by misuse and/or not following these instructions.

Only use parts provided by Mega Slam Hoops, LLC for installation as outlined in this manual as other parts may cause system to fail.

Installation of this product will require heavy lifting. (2) People in good physical condition are recommended for safe installation and assembly.

This is not an indoor light fixture.

Do not look directly into light fixture to avoid any damage to vision.

KEEP CHILDREN AWAY FROM THIS LIGHT FIXTURE.

Light should be unplugged and completely cool before you attempt to replace the fixture. Avoid direct contact of fingers with the fixture.

Do not operate light with broken pieces or missing safety guard.

Keep water and organic material away from system as this could cause failure from rust/corrosion. Check light system regularly for rust. If surface rust is found, remove the affected part and repaint with exterior enamel paint.

Retain this manual for future reference of operation, maintenance and parts information. The information in this manual is based on the latest information available at the time of publication. Your light system may have product improvements and options not yet contained in this manual. Mega Slam Hoops, LLC reserves the right to make changes at any time without notice or obligation.

Contact the manufacturer if technical assistance is required. Additional copies of these instructions are available at www.megaslamhoops.com



WARNING



FAILURE TO FOLLOW THESE WARNINGS & INSTRUCTIONS MAY RESULT IN SERIOUS INJURY, DEATH, AND / OR PROPERTY DAMAGE

Locate your light system away from potential dangers including trip hazards, high traffic areas, or where a vehicle may be in contact with the system.

To avoid serious injury, DO NOT locate the light system under a power line that may come into contact with the system as it is raised. Power lines should not be present within a 20 foot radius of system.

If using a ladder during assembly, use extreme caution. Follow all warnings and cautions on the ladder carefully.

DO NOT CLIMB OR HANG on any part of the goal or light system. This includes the backboard, support braces and any part of the light system. The product is not designed for such use and property damage or personal injuries such as cuts, broken bones, nerve, spinal cord or brain injury or death could occur.

Do not use the system to lift/support anything. When adjusting the system height, keep hands/fingers away from moving parts. DO NOT ALLOW CHILDREN TO ADJUST SYSTEM.

Climate, corrosion, or misuse could result in system failure.

Check system before each use for loose hardware, signs of rust and instability. If the rust has penetrated the steel, replace that part immediately. Repair before each use. Never play on damaged equipment.

Light fixture gets very hot. Unplug power supply and allow to cool before touching surface of fixture.

Do not assemble without the guard and keep light at least 36 inches from any sort of flammable material.

Never operate light around highly flammable liquids.

This light should never be in or near a wet surface. Never use near a swimming pool, hot tub or sauna, or near a standing body of water. Do not operate this light fixture in the rain.

Always insert the plug into the outlet carefully.



Light Post



Light Post



Light Post



Support Bar

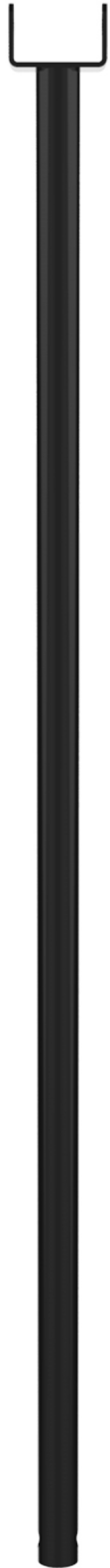

Lift Assist Bar



LED Light Fixture



Light Post Bracket



Light Post

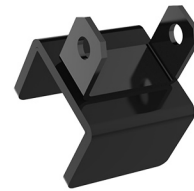

Lift Assist Base

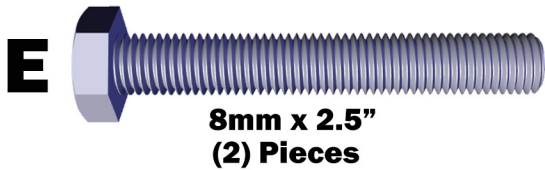
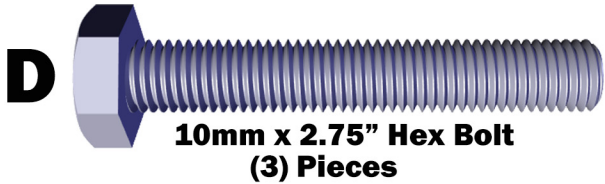

Mounting Kit Hardware

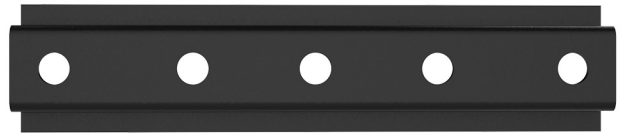

Lower Mounting Brace

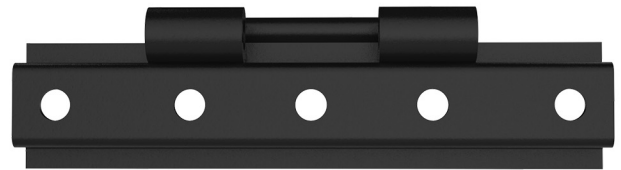

Upper Mounting Brace

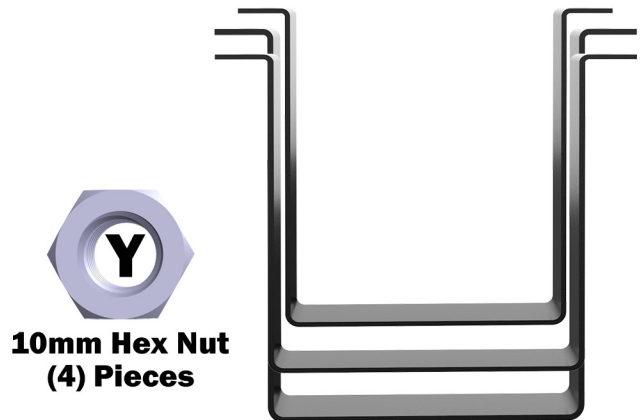
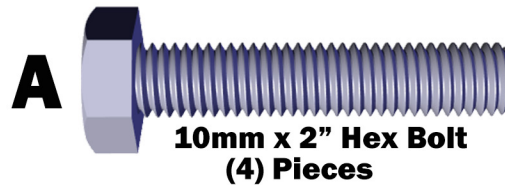
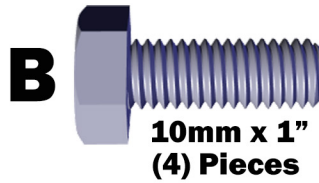

**5" x 5" U Bracket - (2)
6" x 6" U Bracket - (2)
8" x 6" U Bracket - (2)**

Fasteners

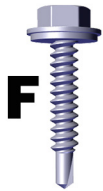

**Self Tapping Screw
(4) Pieces**

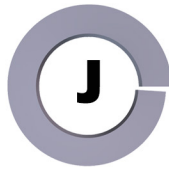

**10mm Lock Washer
(4) Pieces**



**8mm Hex Nut
(2) Pieces**



**8mm Flat Washer
(4) Pieces**



**10mm Hex Nut
(4) Pieces**

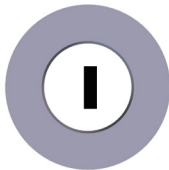

**10mm Flat Washer
(20) Pieces**

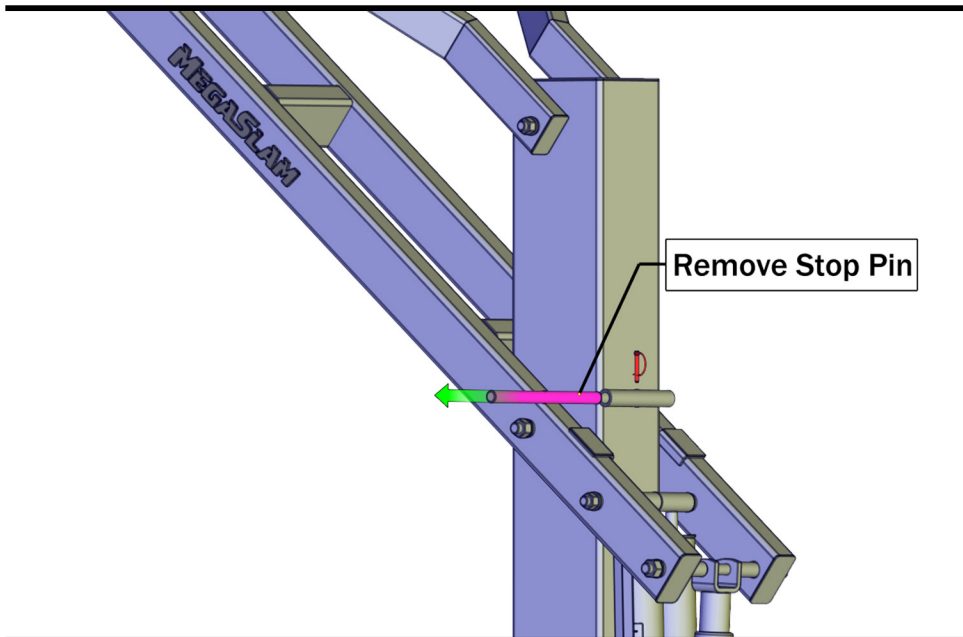

STEP #1 Stop Pin Removal

If you are installing this accessory onto a Mega Slam adjustable system remove the “stop pin” before proceeding.

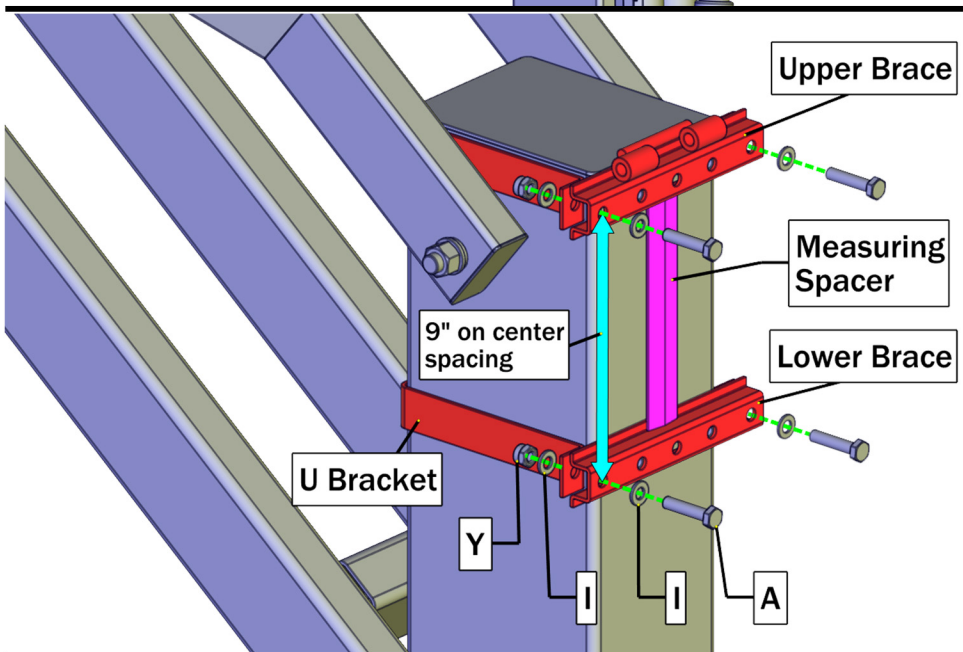

STEP #2 Brace Attachment to Main Pole

First, attach the upper brace to the top of the main pole.

Second, using the measuring spacer make sure the Lower brace is spaced apart 9” on center from Upper Brace. Once spacing is correct, attach Lower Brace to the main pole using the following:

- “Lower Brace” - (1)
- “Upper Brace” - (1)
- “U Bracket” - (2)
- “A” - 10mm x 2” steel bolt (4)
- “I” - 10mm flat washer (8)
- “Y” - 10mm nut (4)

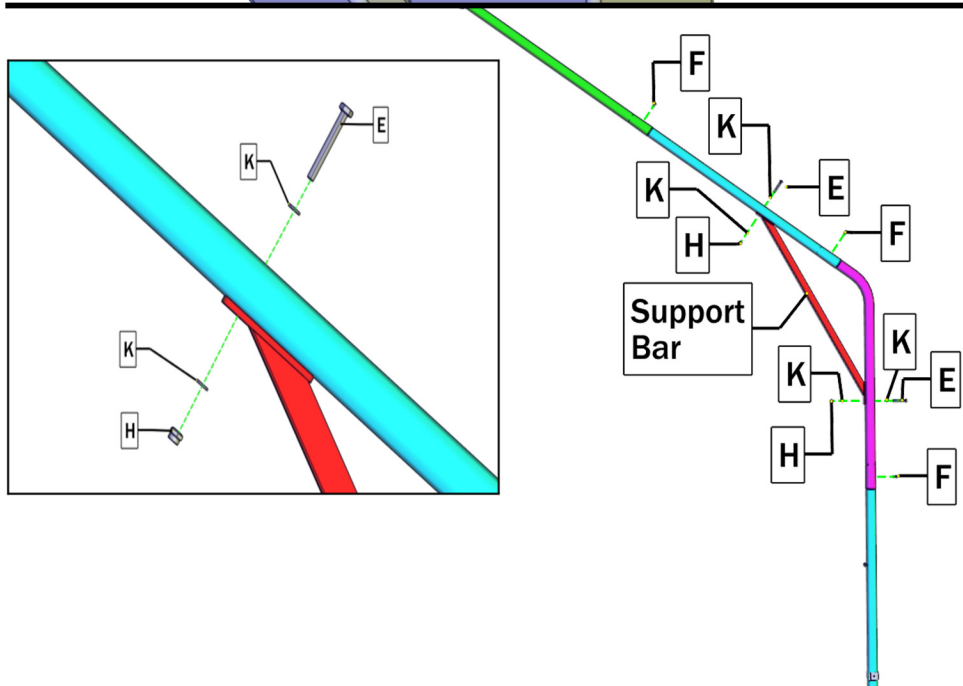

STEP #3 Light Pole Assembly

Find a large area to assemble the four-piece light pole.

First, insert the pole into the curved middle pole, and attach the support bar using the following:

- “E” - 8mm x 2.5” bolt (2)
- “K” - 8mm flat washer (2)
- “H” - 8mm hex nut (2)

Second, insert the top and bottom poles together.

Third, secure the four-piece light pole using the following:

- “F” - self tapping screws (3)

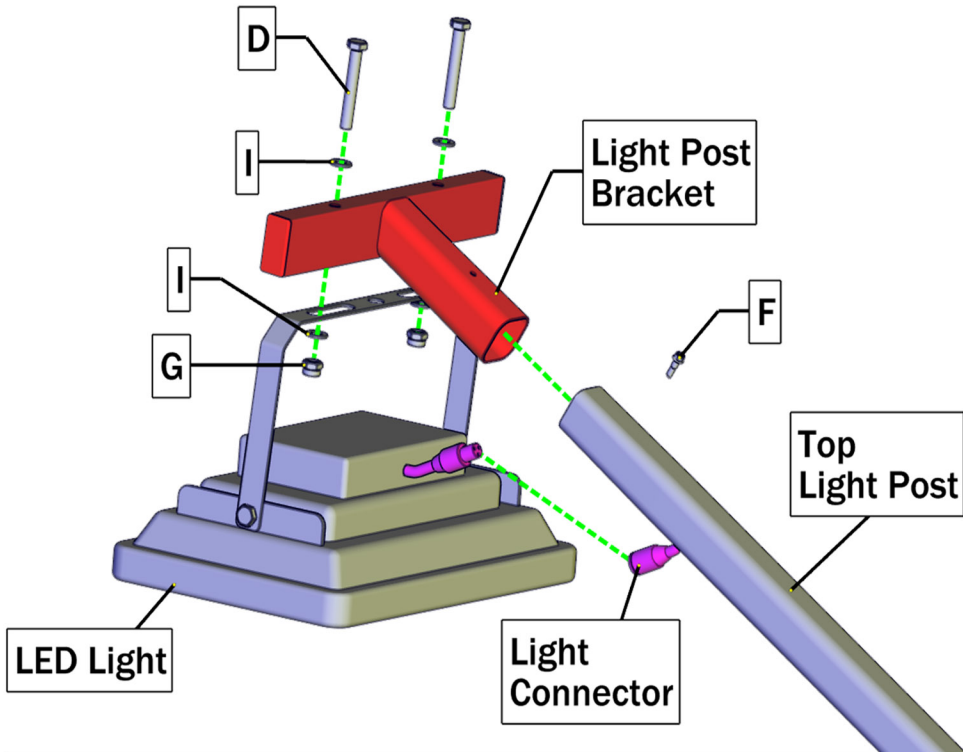
STEP #4**LED Light Assembly**

First, attach the LED light to the Light Post Bracket using the following:

- “D” – 10mm x 3” bolt (2)
- “I” – 10mm flat washer (4)
- “G” – 10mm hex nut (2)

Second, attach the light post bracket to the top light post using (1) “F” self-tapping Screw.

Third, connect the LED light to the LED light connector.

Last, pivot the LED light fixture to appropriate angle for lighting position, and then tighten all bolts.

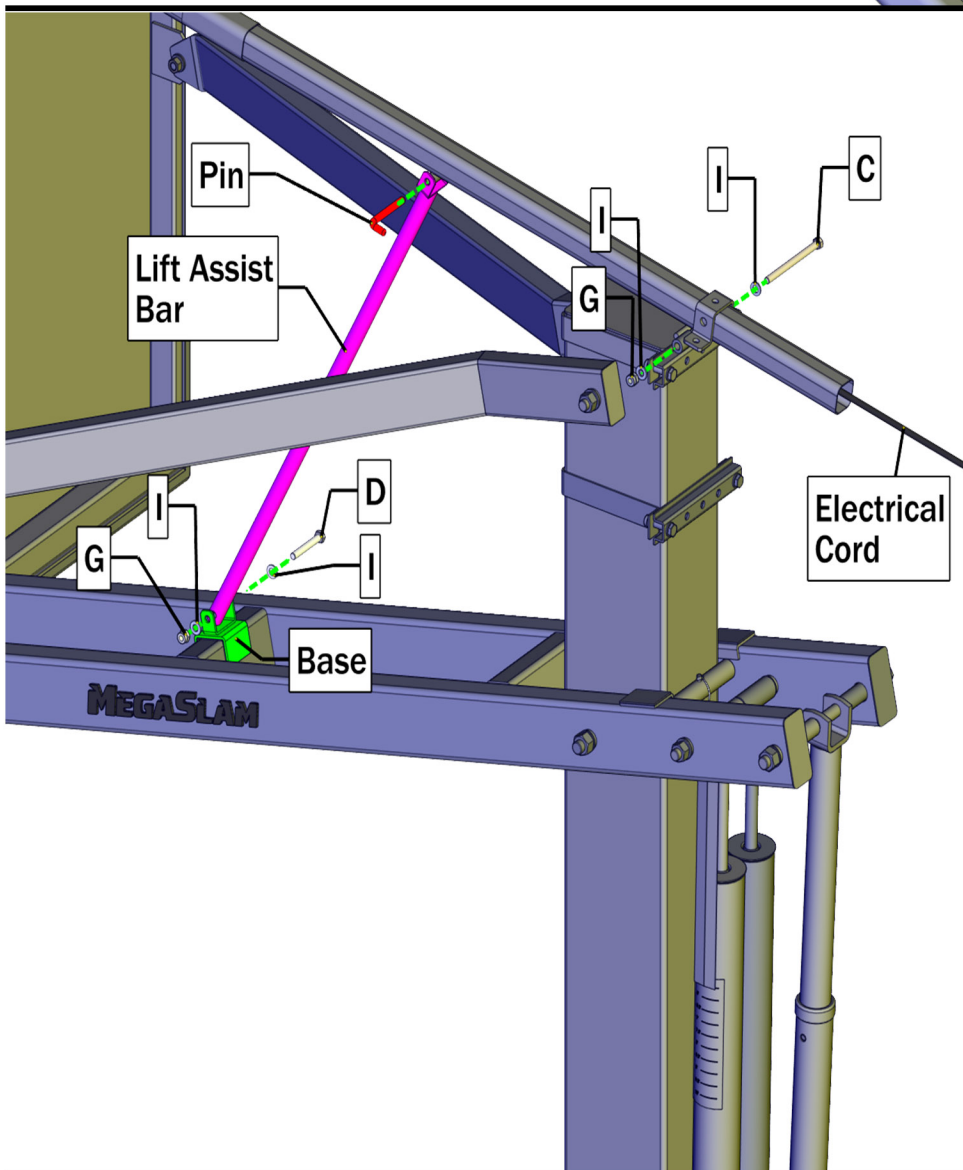
**STEP #5****Light Pole and Lift Assist Bar Attachment to Basketball System****CAUTION**

Attaching the Game Light™ to the pole requires at least two capable adults.

WARNING

When attaching the Game Light™ to the main pole, stay clear of all overhead power lines, electrical lines, telephone lines, and obstacles. Any contact between the Game Light™ and any of these lines will result in severe and immediate danger.

First, lower the backboard to the lowest position. Then attach the “base” to the lift assist bar, and attach the lift assist bar to the light post using (1) “pin”.

Finally, attach the light post to the Upper mounting brace.

STEP #6**Raising Light Post****⚠ WARNING**

Stop rotating the actuator handle when the light post is touching the lower mounting brace. If you continue to rotate the handle to raise the light after the light post is touching the lower mounting brace, you could damage your system.

Begin raising the light post into a vertical position by rotating the actuator handle.

⚠ WARNING

When mounting the Light Post to the basketball pole, be sure that no U-bracket or brace traps or squeezes the electrical cord. Make sure the electrical cord is free and placed outside of the U-brackets and braces. Do not plug the Game Light™ into any electrical outlet or extension cord until the entire assembly procedure is complete.

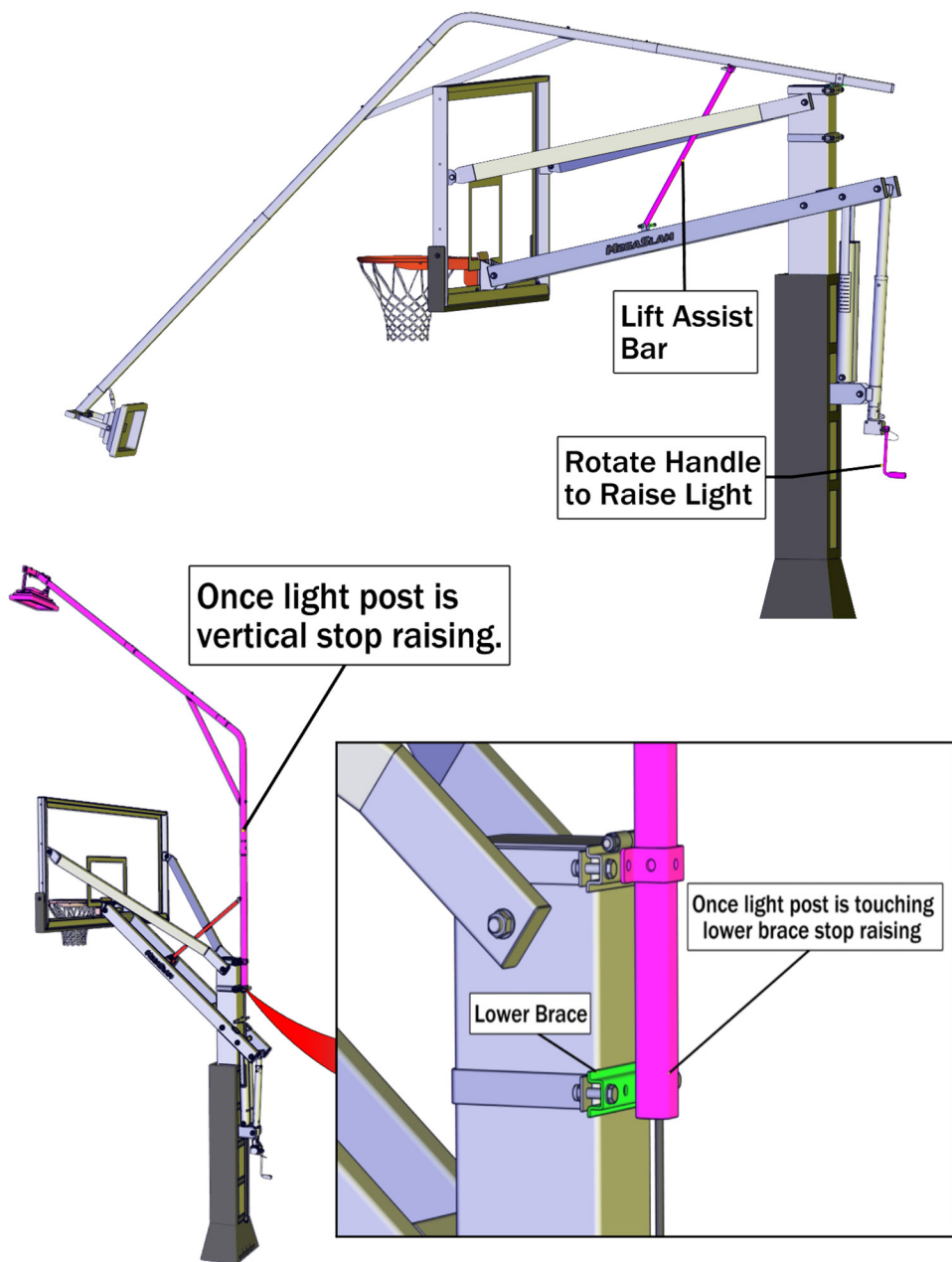
**STEP #7****Securing Light Post to Main Pole**

Attach the Lower Lock Bracket to the Lower Mounting Brace and secure the light post to the Upper Mounting Base using the following:

“B” – 10mm x 1” (4)

“J” – 10mm lock washer (4)

“I” – 10mm flat washer (4)

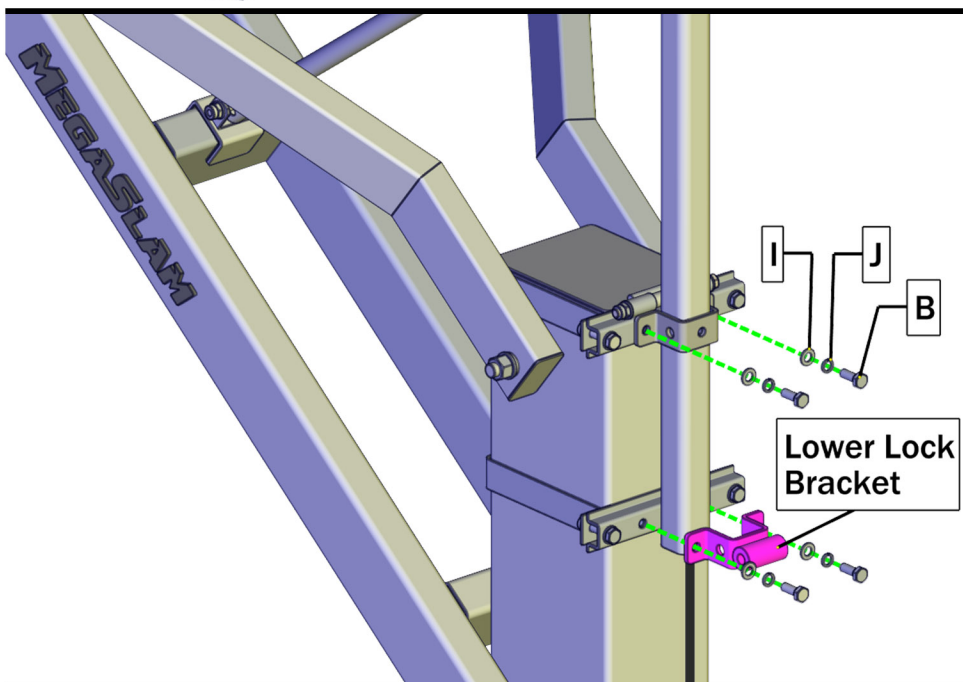

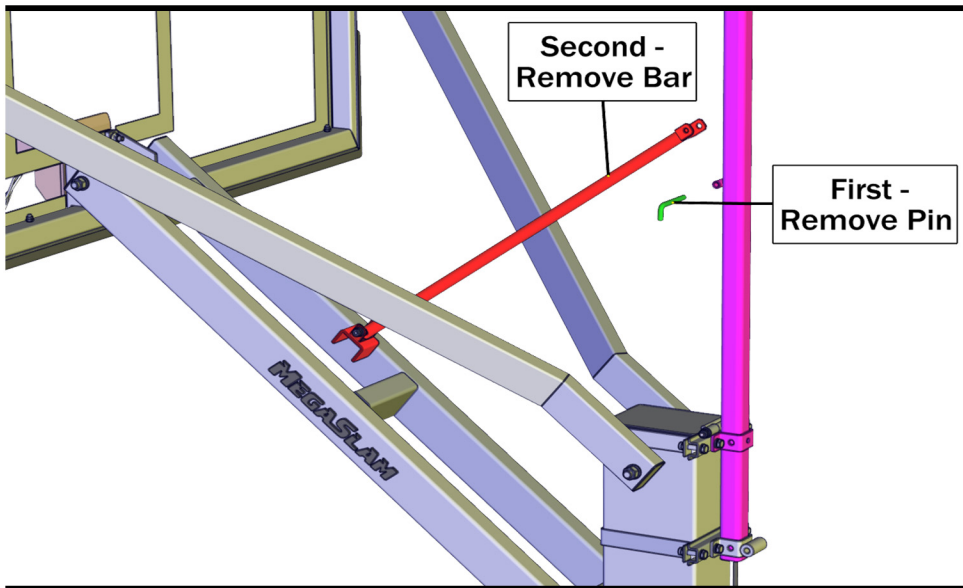

STEP #8 Remove Lift Assist Bar

Remove the pin attaching the lift assist bar to the light post, and then remove the lift assist bar from the system.



STEP #9 Attach Power Cord

CAUTION

Do not operate this light in the rain. When not using your Game Light™, unplug from any power source.

Plug your Game Light™ into an outdoor rated extension cord for a power source.

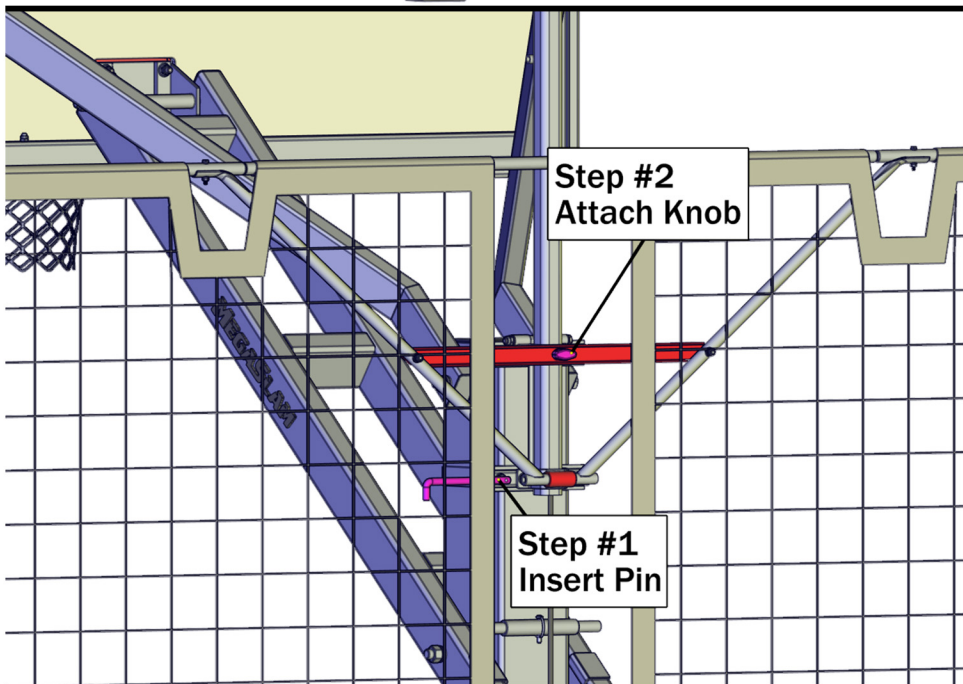

STEP #10 Optional Net Protect™ Attachment

If you also purchased the Net Protect to be used in combination with your Game Light™, the Net Protect™ can be attached after final assembly is completed for the Game Light™.

Insert the pin through the light post, and attach the knob to the rear of the light post.

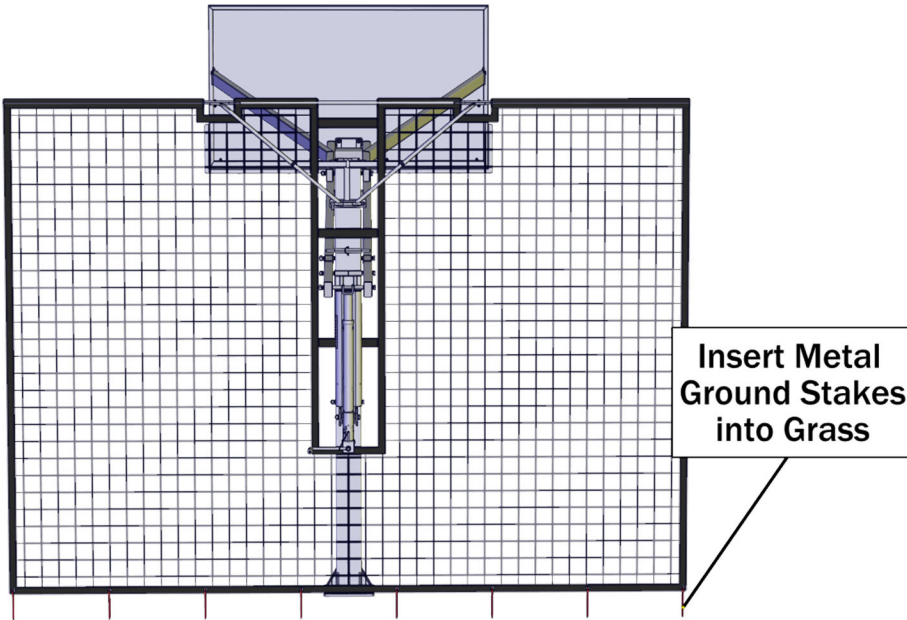

STEP #11

Insert Metal Stakes into the Grass

After securing the net protect to the light post, insert the metal stakes into the ground.

CAUTION

Do not climb or jump on product

Disconnect the Net Protect™ when not in use, especially during bad weather.

STEP #12

Maintenance

Like any piece of hardware proper maintenance is required. Several factors such as the environment, organic materials, herbicides, pesticides, excessive use, or misuse can eventually cause the system to require periodic maintenance. Failure to do so could result in system failure, property damage, or even personal injury.

- a) Keep all organic materials (grass clippings, garbage, etc.) away from the Game Light™ and basketball system to alleviate any chance of rust penetrating the powder coated finish.
- b) Clean the light post periodically with water and a soft cotton cloth. To properly clean the system components use a soft, non-abrasive cloth and water with a mild detergent. Do not use abrasive materials to clean as it could damage the powder-coated finish.
- c) If you see any signs of rust on the Game Light™ or basketball system remove the loose paint, gently sand the area, and apply outdoor enamel gloss paint to the affected area.
- d) Never leave the Game Light™ plugged in when not in use. When not in use disconnect the extension cord from the light, and store the extension cord indoors.
- e) Never use your Game Light™ during rain, or after precipitation.

STEP #13

Routine System Inspection

Before each use inspect the Game Light™ for any signs of the following:

- Loose nuts and bolts
- All parts and components for excessive wear and tear
- Any signs of rust or corrosion

If replacement parts are needed, only replacement parts from Mega Slam Hoops, LLC should be used in the repair process. Use of other parts may cause the system to fail resulting in serious injury or death and will void the manufacturers' limited lifetime warranty.